





USER GUIDE



Original

robomow.com   

Robotic Mower
RT300, RT700

Safety first.....	2
Installation	15
Quick reference	35

Safety First

IMPORTANT!

READ THIS SAFETY GUIDE CAREFULLY BEFORE USE.
KEEP FOR FUTURE REFERENCE

1 Safe Operation Practices

2 Symbols Definitions

3 Safety Features

This product is an autonomous robotic mower, powered by a rechargeable Li-Ion battery and includes a Base Station.

The mower will independently depart from the Base Station, mow the lawn and return to the base for charging.

A pre-installed perimeter wire connected to the Base Station sets the boundaries (a "virtual wall") for the mower. It will be laid around the edges of the lawn and around objects that the mower should avoid.

The mower moves randomly within its working area, as defined by the perimeter wire.

The mower includes Bluetooth and GSM radio modules (on selected models).



Do not allow children to use or operate the mower.
Children must be supervised at all times.

This guide includes the original manufacturer's instructions in terms of Directives 2006/42/EC and 2014/53/EU. It may describe models that are not available in your country.

Please note the terminology below when using this guide.

Front and Rear of the mower:

The Front is the side where the carrying handle is located. It is the direction of travel of the mower.

The Rear is where the small supporting wheel is located.

Left and Right directions are determined when standing behind the Rear of the mower and looking at its Front.

Safety Guidelines



DANGER

Describes situations, where, if the hazard is not avoided, it will cause death or serious injury.



WARNING

Describes situations, where, if the hazard is not avoided, it may result in death or serious injury.



CAUTION

Describes situations, where, if the hazard is not avoided, it could result in minor or moderate injury, or damage to property and/or the product.



Provides information for proper use of the product and avoidance of possible operation malfunctions.

Important Safety Information



WARNING

It is your responsibility to:

- Restrict the use of this mower to persons who have read, understood and follow the warnings and instructions in this guide and in the mower
- Inform your neighbors you have a robot mower in operation and that they may be injured if they enter your lawn during operation



DANGER

Always connect the power supply to the indoor, weather-protected power supply circuit protected by a residual current device (RCD) with a tripping current of not more than 30 mA. Follow local electric installation instructions.



WARNING

Allow the blades to completely stop rotating before lifting or tilting the mower or approaching the blades.



DANGER

The AC power supply cord must not be replaced! If the cord is damaged, the entire power supply should be replaced. Do not connect a damaged power cord to the supply and do not touch such cord as it can cause electric shock.

Keep all power cords away from underneath the mower to prevent damage.



CAUTION

In case of a lightning storm, disconnect the perimeter wire from the Base Station and unplug its power supply from the AC socket.



Safe Operation Practices

A. General Information

1. Read, understand and follow all instructions on the mower and in the manual(s) before attempting to assemble and operate. Keep this manual in a safe place for future and regular reference and for ordering replacement parts.
2. Be familiar with all controls and their proper operation.
3. It is your responsibility to inform your neighbors you have a robotic mower and the risk of injury if they enter your lawn during its operation.
4. If your lawn is open to the street and/or your neighbor's property, you must be present during the mower's operation to prevent others from contacting the mower during operation. Alternatively, you must fence your lawn so that others do not access the lawn during operation.
5. Never allow children under 14 years of age to operate the mower using the remote control app. Children 14 and over should read and understand the instructions and safe operation practices in this manual and on the mower and should be trained and supervised by an adult.
6. Never allow children, persons with reduced physical, sensory or mental capabilities, or people who are unfamiliar with these instructions to operate the mower.
7. If situations occur which are not covered in this manual, use care and good judgment. Contact your customer service representative for assistance.
8. This mower is a precision piece of power equipment, not a plaything. Therefore, exercise extreme caution at all times. This mower has been designed to perform one job: to mow grass. Do not use it for any other purpose.

B. Preparations Before Operating



PRIOR TO FIRST USE, ENSURE THAT PRODUCT HAS BEEN CHARGED CONTINUOUSLY FOR 48 HOURS.

1. Ensure the correct installation of the Perimeter Wire, as instructed later in this manual.
2. Thoroughly inspect the area where the mower is to be used. Remove all stones, sticks, wire, bones, toys and other foreign objects which could damage the blade or be picked up and thrown by the blade. Thrown objects can cause serious personal injury.
3. Keep bystanders, children and pets inside while the mower is in operation. Stop mower if anyone enters the mowing area.
4. When there is a risk of a lightning storm, keep the mower in a protected area and disconnect the power supply.

C. Operation



WARNING

Do not allow the mower to operate unattended if you know that there are or may be pets, children or people in the vicinity.

1. Your robotic mower is a dangerous power tool. Exercise care when operating it and follow all safety instructions and warnings.
2. In the event of an accident or malfunction during operation immediately press the red STOP control.
3. Do not allow your mower to operate if any safety feature or any part is damaged, worn or inoperable.
4. Always turn off the mower by removing the disabling device before lifting the mower or clearing blockage of the mowing blade(s) and/or driving wheels or making any adjustments. Activating the disabling device cuts power to the wheel drive and blade.
5. Never pick up or carry the mower while the wheels are turning or blade is moving. Do not touch the blade before it has completely stopped rotating.
6. Do not use the mower for any purpose other than cutting grass.
7. Never attempt to bypass a safety device, or to remove a guard or cover. Doing so may result in personal injury through contact with the rotating blade. The sensors are safety devices.
8. The cutting blade continues to rotate for up to two (2) seconds after a safety sensor is triggered or the red STOP control is pressed. Never place any part of the body in the blade area until you are certain the blade has stopped rotating.
9. If the mower should start to vibrate abnormally, stop the motor and check immediately for the cause. Vibration is generally a warning of trouble.
10. Always wear safety glasses during remote control operation and while performing an adjustment or repair to protect your eyes. Thrown objects which ricochet can cause serious injury to the eyes.
11. Never operate mower with a damaged safety device, guard or cover. Failure to follow this warning can result in personal injury.
12. Do not put hands or feet near rotating parts or under the cutting deck. Contact with the blade(s) can amputate hands and feet.
13. Watch for holes, ruts, bumps, rocks or other hidden objects. Uneven terrain or hidden objects could cause an accident. Tall grass can hide obstacles.
14. Your mower is designed to cut normal residential grass of a height no more than 6" (15 cm). Do not attempt to mow through unusually tall grass (e.g., pasture).

15. Set the weekly program so the mower is in operation when there are no people likely to be on the grass.
16. Do not connect a damaged power cord to the supply, or touch a damaged cord before it is disconnected from the supply as it can lead to electric shock.
17. Keep all power cords away from underneath the mower to prevent damage. A damaged power supply cord can lead to electric shock. Disconnect the AC plug from the mains if the cord is damaged or entangled. **DO NOT TOUCH THE CORD BEFORE DISCONNECTING THE SUPPLY.** When the AC/DC power supply installed outdoor, do not operate or disconnect it when the temperature exceeds 0...40C range to avoid the risk of fire
18. Steering the mower manually only when it is within your range of vision. Stay within 6 meters of the mower when you are operating it manually.

D. Children

1. Tragic accidents can occur if you are not alert to the presence of children. Children are often attracted to the mower and the mowing activity. They do not understand the dangers. Never assume that children will remain where you last saw them. Never assume that children will stay away from the mower while it is operating.
2. Keep bystanders, children and pets inside while the mower is in operation and under the watchful care of a responsible adult. Stop mower if anyone enters the area.
3. Be alert and turn the mower off if a child or bystander enters the area.
4. Do not allow children to ride on the mower. It is not a toy.
5. Never allow children to play in the yard while the mower is in operation. Teach your children that the mower is dangerous and they must stay away from it.
6. Never allow children under 14 years of age to operate this mower using the remote control app. Children 14 and over should read and understand the instructions and safe operation practices in this manual and on the mower and should be trained and supervised by an adult.

E. Transportation

Before moving or transporting your mower, follow the steps below:

1. You may use the Remote Control (via the mobile app) to drive your mower from one place to another.
2. If you select to carry your mower, Switch the mower off by removing the disabling device, then pressing the Power button. Lift the mower using the carrying handle.
3. Always carry with blades facing away from you. Be careful to avoid contacting the sharp edge of the blade when lifting or carrying the mower.

F. Remote Operation

1. Refer to the separate operator's manual provided with the downloadable app. Follow all warnings and instructions provided.
2. Always operate the mower according to the app instructions while standing away from the mower.
3. Keep a safe distance between you and the mower when it is in operation. Always stop the mower operation before approaching it for any reason.
4. Use extreme caution when operating the mower towards you.
5. Operate the mower by remotely only in daylight or in good artificial light, and avoid operating on wet grass.
6. Never operate the mower remotely in bare feet, sandals, slippery or lightweight (e.g. canvas) shoes. Always wear substantial footwear and long pants; always make sure of your footing on slopes.

G. Batteries

1. Use only genuine batteries provided by the manufacturer. Batteries part numbers are specified in the 'Additional Information' booklet.
2. Do not open, drop, or damage the sealed Battery Pack. Do not use the battery with visible defects or deformations, when it is broken or cracked
3. **DO NOT ATTEMPT TO REPAIR OR MODIFY BATTERIES!** Repair attempts may result in severe personal injury, due to explosion or electrical shock. If a leak develops, released electrolytes are corrosive and toxic
4. Do not attempt to remove or destroy any of the battery components.
5. The Battery Pack contains electrolytes. In the case of electrolyte leakage from the Battery Pack, the following action should be taken:
 - Skin contact: Wash the contact areas off immediately with water and soap.
 - Eye contact: Flush the eyes with plenty of clean water for at least 15 minutes. Do not rub.
 - Get medical assistance.
6. Do not dispose of the battery in a fire. The cell may explode.
7. The battery is intended to be charged when it is inside the mower and properly connected to the mower. Always use the power supply provided with the mower. Incorrect usage may result in electric shock, overheating or fire.
8. Do not use the battery for any purpose other than powering the dedicated Robotic Lawnmower. Altering the battery to make it powering another product is extremely unsafe.
9. Observe proper disposal laws and regulations for batteries to protect the environment. Refer to the "Rechargeable Battery Disposal" section of this User Guide for additional information.
10. When replacing the battery, be sure to insert the battery plug correctly. Reversing the battery polarity may cause damage to the battery and mower.

H. Slope Operation

1. All slopes require extra caution. If you feel the mower cannot maintain traction on the slope, it is too steep to mow. Wet grass will decrease traction and may cause the mower to slip and slide on the slope. Serious injury or property damage could result.
2. For your safety, measure any slope before using the mower on the sloped area. Use a slope measuring device before setting up the mowing zones or operating this mower on a sloped or hilly area. Smart phone applications can also be utilized to measure slopes. If the slope at the perimeter is greater than 17 degrees (30%), RT models may slide out of the mowing zone.
3. Do not mow on slopes greater than 17 degrees (30%).
4. Do not operate the mower under any conditions where traction or stability is in question. Always be sure of the mowing surface. A tip or overturn could cause serious personal injury or property damage.
5. Stay at least 4 feet (1.2 meter) from drop-offs, ditches, embankments or the edge of water to help ensure the mower does not get out of the mowing zone. You could damage the mower or cause a serious injury.

I. Maintenance and Special Instructions

1. Keep the mower in good working order. Replace worn, damaged or broken parts. Manufacturer part numbers of the batteries, blades and power supplies are specified in the 'Additional Information' booklet.
2. To avoid serious injury do not modify the mower in any way.
3. Mower blades are sharp. Wrap the blade or wear gloves and use extra caution when changing the blade.
4. Always switch off the mower by removing the disabling device before servicing or clearing blockage of the mowing blade(s) and/or driving wheels or inspecting. Never attempt to service or adjust the mower while it is in operation. Before cleaning, repairing or inspecting, make certain the blade and all moving parts have stopped.
5. The blade should come to a complete stop within two (2) seconds after pressing the red stop control. If you do not hear the blade stop in less than two (2) seconds, your mower must be serviced professionally by an authorized service dealer.
6. Never use a high pressure power washer or hose to clean the mower. Water can damage components and the programmable controller. Use a damp cloth to wipe the display clean.
7. Visually inspect blade for damage (e.g., excessive wear, bent, cracked). Replace the blade with the original equipment manufacturer's (O.E.M.) blade only. Non-O.E.M. blades will not fit properly and could potentially be unsafe.
8. Use of service parts which do not meet the original equipment specifications may lead to improper performance and compromise safety.
9. After striking a foreign object, or getting hung up, stop the mower. Thoroughly inspect the mower for any damage. Repair the damage before starting and operating.

10. For areas close to a children's play area, bodies of water, drop offs or public roads, supplement the perimeter wire with a rigid (wood/stone) boundary edge at least 15 cm (6 inches) high which will help prevent the mower from exiting the mowing zone.
11. If your mower is installed and operated in an open yard or in a public location, you must place warning signs around those mowing areas, showing the substance of the following: "Automatic Lawnmower! Keep away from the machine! Supervise children!"
12. Clean or replace safety and instruction labels, as necessary.

J. Winter Storage

The Mower

Fully charge the mower in its Base Station. Switch it off. Clean the mower and store it in dry indoor conditions at ambient temperatures above 0°C.

Base Station

No special winter storage instructions are required for the Base Station. It can be left on the lawn during winter period.

It is recommended to disconnect the Power Supply from the mains during winter.

Annual Service

To keep your mower in good condition, it is recommended to bring it to a certified dealer for service before or after winter storage.









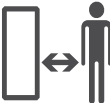

The annual service may vary between different service providers and will include all or some of the following: cleaning mower's parts and mowing deck, checking for worn parts (such as blades, drive wheels and other moving parts) and replacing them if required, testing the mower's functions and safety components, checking the battery and uploading a latest software version, possibly including newly added features.

K. Product End of Use

1. The mower and its accessories should be properly disposed of at the end of their useful life to prevent waste electrical and electronic equipment from ending up in landfill sites, and to protect and improve the quality of the environment. Check with your local trash facility or municipality regarding disposal laws. Many municipalities provide special waste collection sites for the disposal of batteries and electronic equipment.
2. Do not dispose of the Battery Pack or the mower in unsorted municipal/household trash.
3. Do not dispose of the Battery Pack in a fire.
4. See local and state regulations for any special disposal or recycling laws and requirements. Refer to end of the Quick Reference section for disposal instructions.

2

Symbols Definitions

Symbol	Description
	<p>WARNING — READ THE OPERATOR'S MANUAL(S)</p> <p>Read, understand and follow all the safety rules and instructions in the manual(s) and on the mower before attempting to operate this mower. Failure to comply with this information may result in personal injury or death. Keep this manual in a safe location for future and regular reference.</p>
	<p>DANGER — AVOID AMPUTATION INJURY</p> <p>Do not put hands or feet near or under the cutting deck. Contact with the blade can amputate hands and feet.</p>
	<p>WARNING — AVOID CRASH/BLADE INJURY. KEEP A SAFE DISTANCE FROM THE MACHINE WHEN OPERATING.</p> <p>Do not mow when children or others are around. To help avoid blade contact or a thrown object injury keep others away from the mower while it is in operation. Keep bystanders, children and pets inside while the mower is in operation. Stop mower if anyone enters the area.</p>
	<p>WARNING — AVOID THROWN OBJECT INJURY</p> <p>Keep bystanders at least 15' (5 meters) from mower during operation. Remove all stones, sticks, wire, bones, toys and other foreign objects which could be picked up and thrown by the blade(s). Do not operate the mower without the entire cover or guards in their proper place.</p>
	<p>WARNING — AVOID CRASH/BLADE INJURY</p> <p>Do not allow children to ride on the mower. It is not a toy.</p>
	<p>WARNING</p> <p>Shut off the mower before attempting to service it.</p>
	
	<p>WARNING</p> <p>Remove the disabling device before working on or lifting the machine</p>
	
	<p>WARNING - USE ONLY ORIGINAL POWER SUPPLY</p> <p>Do not alter the power supply connection! Use only the original power supply unit provided by the manufacturer, with the mower or as a spare part. The correct part number is indicated on the product, on this label. A non-original power supply may result in fire and damage to the base station and the mower.</p>

3 Safety Features



WARNING

Your mower is equipped with numerous built-in safety features. However, the mower is a hazardous device with sharp blades, which can cause major injury to anyone who comes in contact with it.

Therefore, it is absolutely forbidden to be on the lawn while the mower is working.

A. Child Lock

The Child Lock prevents unintended operation of the mower by an accidental press of one of the buttons. Only pressing two buttons in the right order will initiate the operation. It is required to activate the Child Lock feature if children under age 6 may come in contact with the mower.

B. Anti-Theft Device (Code protected disabling device)

The Anti-Theft Device system function will prevent anyone from using or driving the mower unless they have a valid code to enter. You will be prompted to enter a four digit code of your choice to use as your personal security code (for models RT it is available using mobile app only). It is highly recommended to activate this feature to prevent operation of the mower by children or people who are unfamiliar with the mower or not allowed to use it.

C. Lift Sensor

If the mower is manually lifted off the ground, the mower and rotation of the blade will stop in two (2) seconds.

D. Tilt Sensor

If the mower is tilted up towards a vertical position, the mower and rotation of the blade will stop in two (2) seconds.

E. Obstruction Sensor

Your mower detects interfering obstacles in its way during operation. When the mower collides with an obstacle it will stop movement in that direction, reverse itself away from the obstacle and the mower and rotation of the blade will stop in two (2) seconds.

F. Quick Stop Control

Pressing down the red STOP control at any time during operation will stop the mower and the blade in (2) two seconds.

G. Removable Disabling Device

Pulling out the disabling device will prevent any operation of the mower. It is required to pull the disabling device before lifting the mower and before any maintenance is done.

H. Base Station/Perimeter Switch and Perimeter Wire

The mower cannot operate without a Perimeter Wire installed and activated through the Base Station/Perimeter Switch. In the event the Perimeter Wire signal is turned off, the mower will stop operating.

***Let's get
started.
Can't wait
to mow your
lawn.***



Installation

Congratulations on purchasing your new mower!

Your new mower will move randomly within its working area, as defined by the Perimeter Wire. This kind of random movement provides the perfect cut and ensures complete coverage of your lawn.

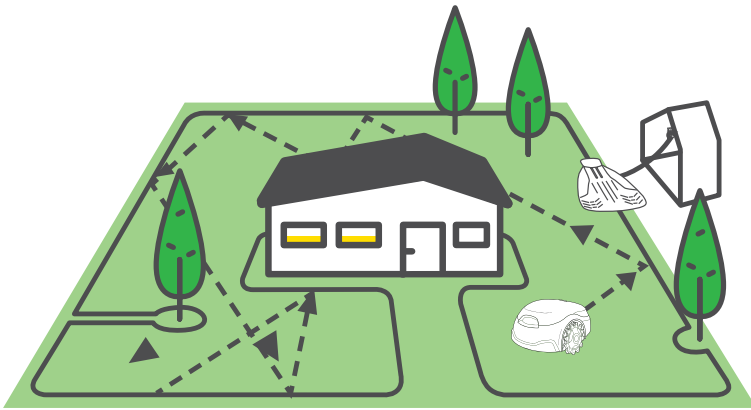

At the end of each mowing ride, your mower will follow the Perimeter Wire and automatically return to the Base Station for charging.

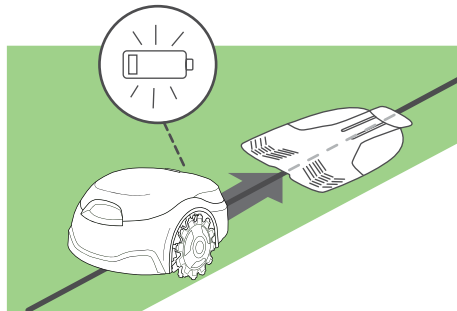

After a quick and simple installation, you will be ready to enjoy your free time while your new friend looks after your lawn.

So where are we heading?

Correct installation of your mower will ensure maximum results. This is what it takes to prepare it to do a perfect job for you.

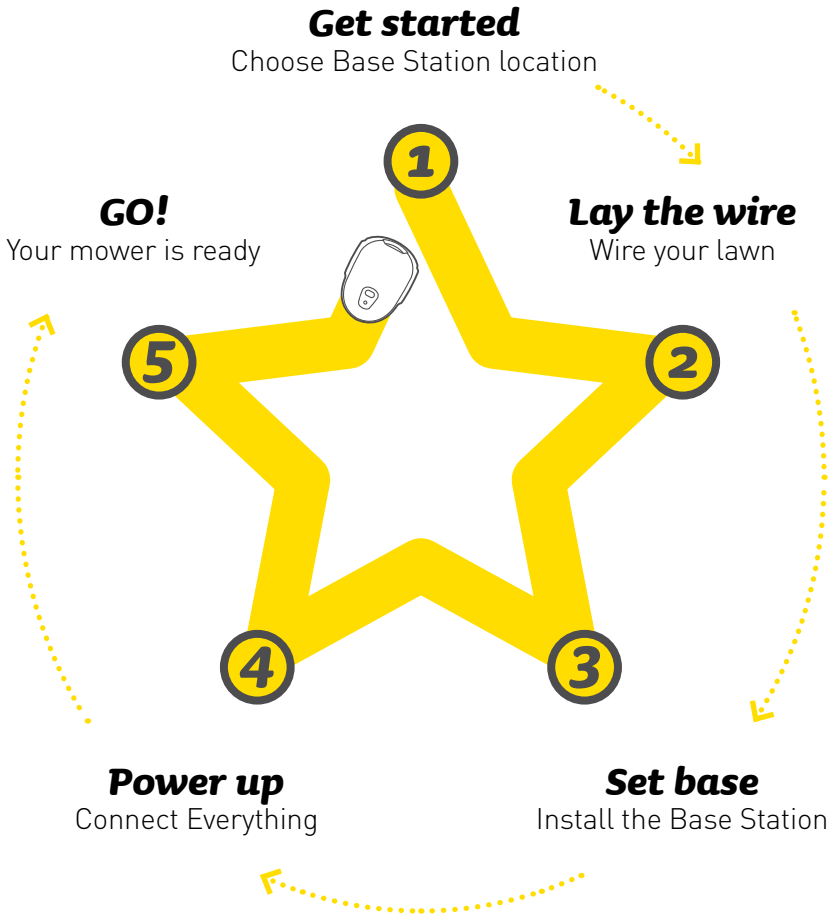

This is what you find in the box

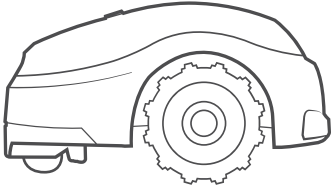

The product

Your new Robotic Mower

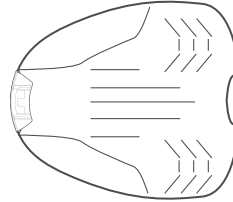

Base Station

This is where the mower recharges

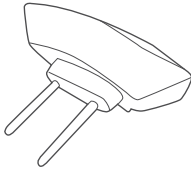

Base Station Head

Generates Perimeter Wire signal

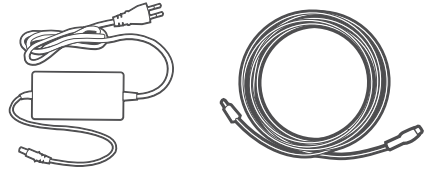

Power Supply + 10m Extension Cable

With 10 m / 33 ft extension cable

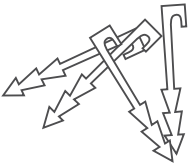

Wire Pegs*

For securing the wire to the ground
() Not provided with Pro models*

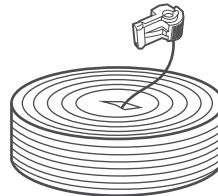

Perimeter Wire with a plot connector*

Marks the working area for your mower
() Not provided with Pro models*

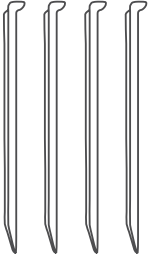

Base Station Stakes (x4)

For affixing the Base Station to the ground



Wire Connectors

For splicing the Perimeter Wire in case of a cut

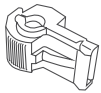

Plot Connectors

For connecting the Perimeter Wire to the Base Station



Getting Started Guide
+
Safety Instructions



RoboRuler

For measuring the Perimeter Wire's distance from the lawn's edge

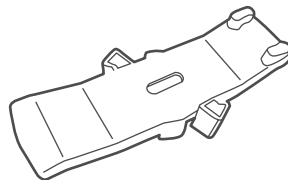

RoboTool

For blades replacement and servicing. **IMPORTANT! Keep this tool for future use.**

Ready? Let's begin...

1 Get started

Choosing the Base Station location

The Base Station is where your mower recharges, and where the Perimeter Wire starts and ends.

Follow these simple guidelines to find a proper location for your Base Station

Rule #1:

Up to 10 meters / 33 feet away from a power outlet

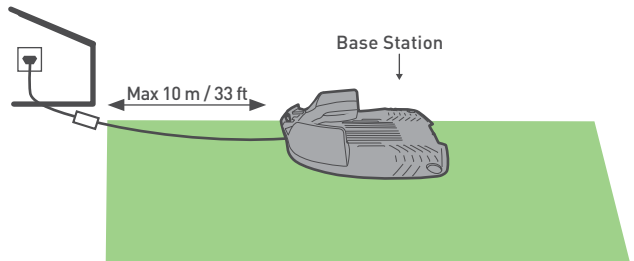

Rule #2:

A min. of 1 meter / 3.3 feet straight wire before, after and aside the base to allow smooth docking



For proper charging and better lifespan of the battery, it is recommended to locate the base station in a place that is shaded most of the day

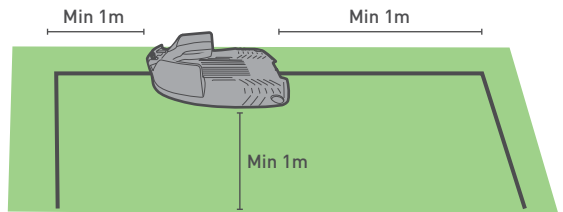

Rule #3:

Even and flat (up to +/-5% slope)

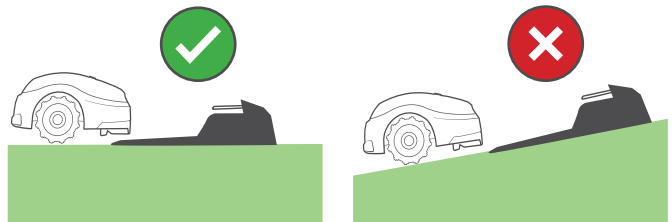

Rule #4:

A minimum of 1 meter / 3.3 feet from a sprinkler head to avoid hitting the mower directly and damaging its internal components

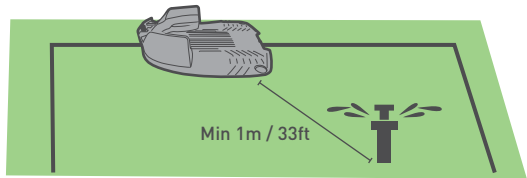

Watch the proper direction of the Base Station relative to the lawn's edge

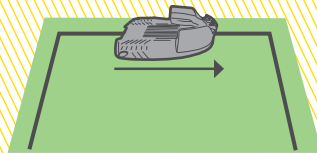
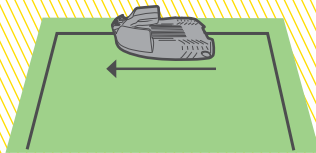

The Base Station will be installed at a later stage, after the Perimeter Wire is in place.

**** See additional installation options in Appendix A ****

2 Lay the wire

Lay the Perimeter Wire (“virtual boundary”), which defines the working area for the mower.



- Have mower’s package nearby.
- Before you start wiring, mow the lawn using a conventional lawn mower to 3-4 cm height.
- If the soil is dry and hard, water the mowing area in order to make it easier to drive the wire pegs.



WHAT YOU’LL NEED



Hammer



Combination pliers



Cutter

A. Get to know wire distances

Use the RoboRuler to determine a distance, which you should keep between the Perimeter Wire and the lawn’s edge.



If the edge is relatively flat, lay the wire at RoboRuler distance **2** from it.

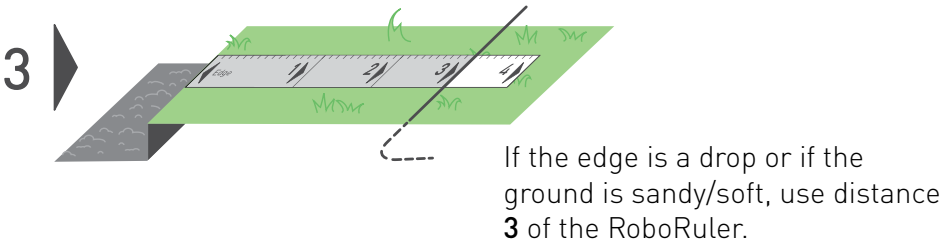
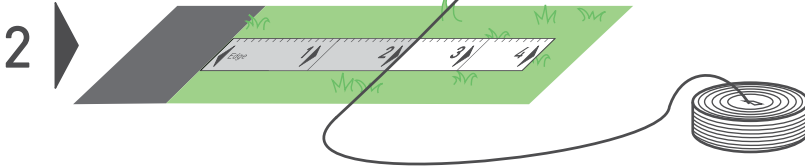

If the edge is a drop or if the ground is sandy/soft, use distance **3** of the RoboRuler.

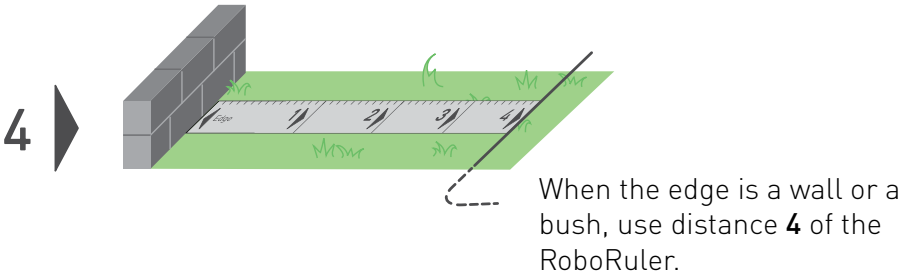

When the edge is a wall or a bush, use distance **4** of the RoboRuler.



Keep a minimum of 1.2 m (4 ft) if the edge of the lawn borders water.

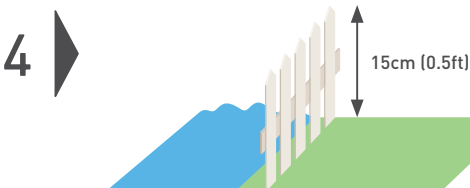

Alternatively, place a physical barrier close to the water.

B. Make a good start

- Pull out the wire end marked “A” from the Perimeter Wire spool
- Leave a tail of approx. 30 cm / 12”

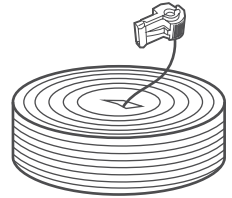

- Once a tail is made, secure it to the ground where you intend to install your Base Station. Measure the correct RoboRuler distance from the edge:

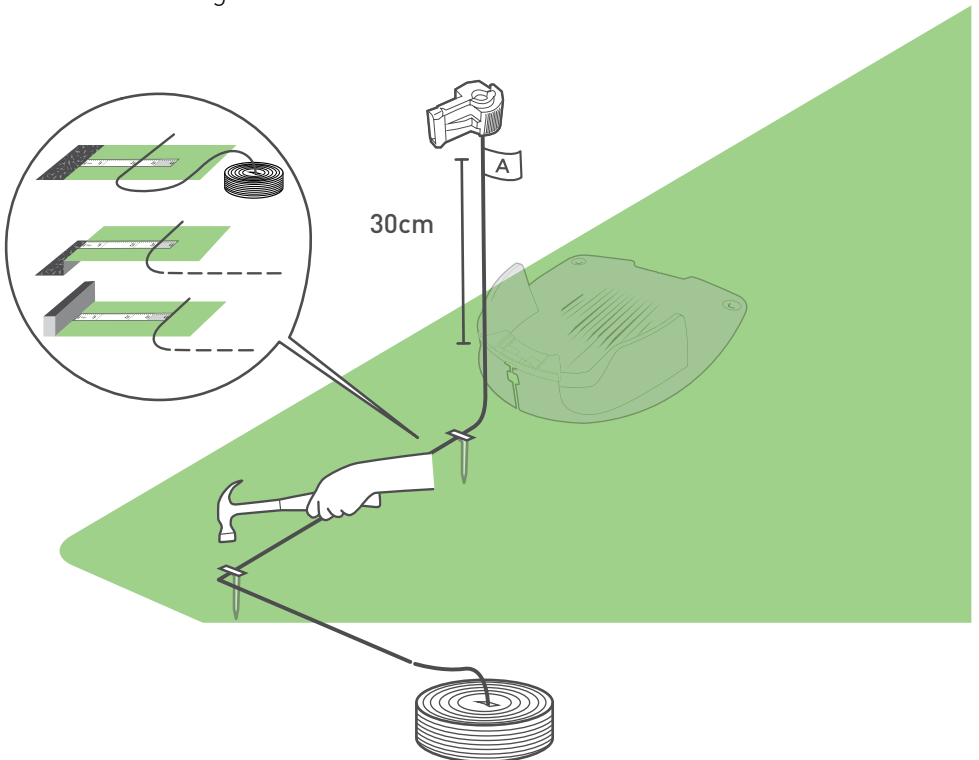



SLOPES

Slopes along the edge

To ensure your mower doesn't slip off the lawn, especially when the grass is wet, the Perimeter Wire must exclude a slope along the edge of your lawn with an incline of over 10% - that is, 10 cm rise per 1 m [4 in rise per 3 ft].

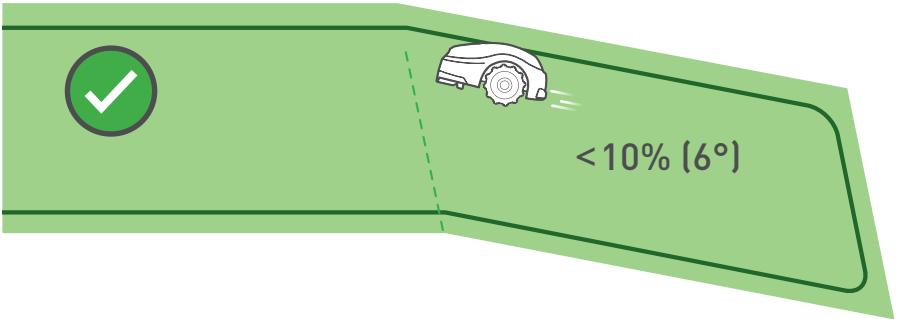

10% =

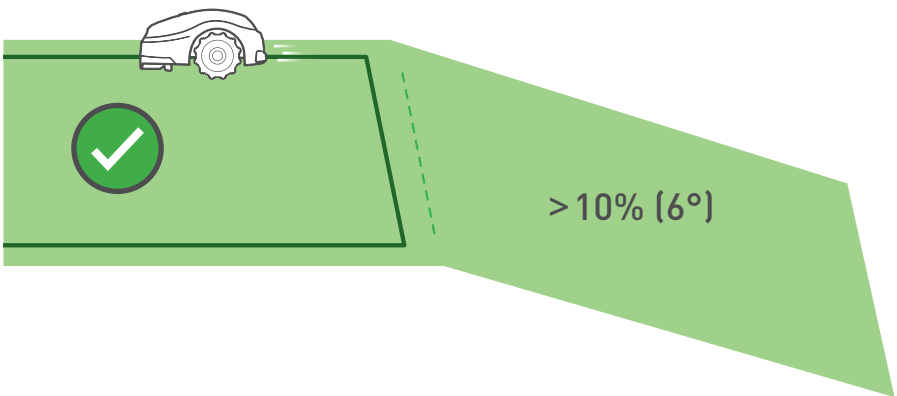
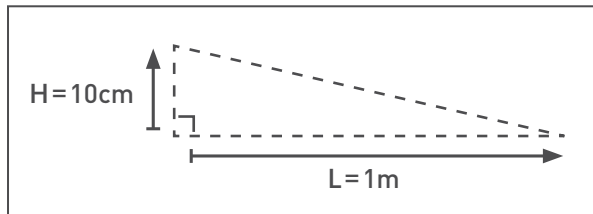

Well done! This was the most complex part of the wire installation. Let's move on...

Slopes within the lawn

Your mower can mow areas within the lawn with a slope of up to 30% [30 cm rise per 1 m/1 ft rise per 3 ft].

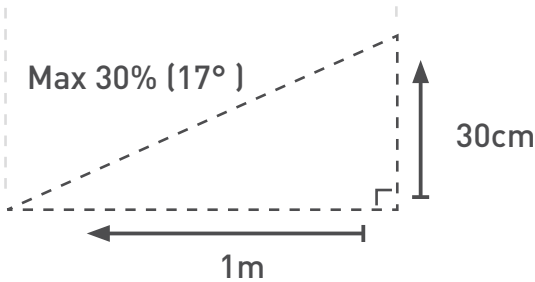
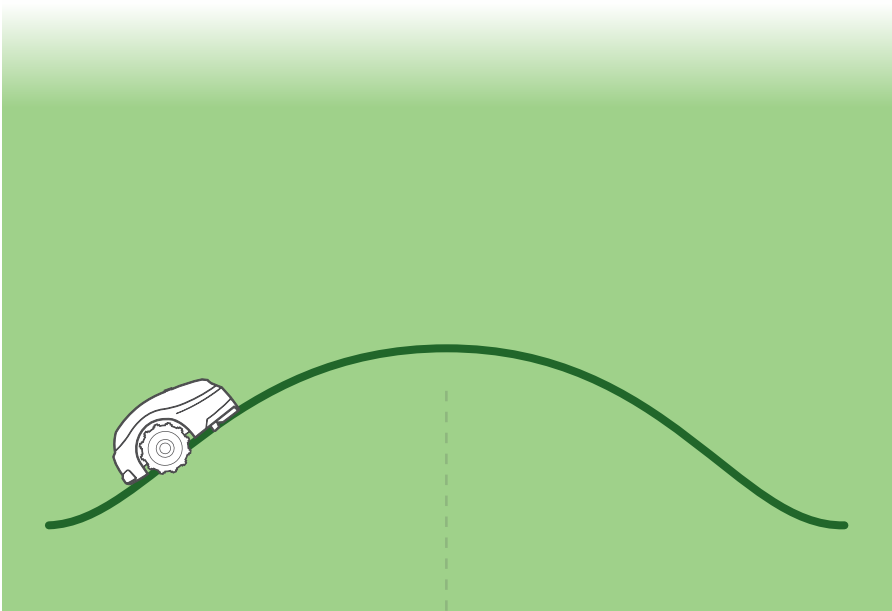

C. Keep laying the wire



Start unwinding the wire counter clockwise around the lawn starting at the Base Station's location.

Lay the Perimeter Wire loosely along the perimeter as you walk along the lawn's edge.

- The Perimeter Wire is secured to the ground by the pegs supplied with the product.
- Pull the wire tight while hammering the pegs to their final depth in the ground.
- Take care not to damage irrigation pipes.

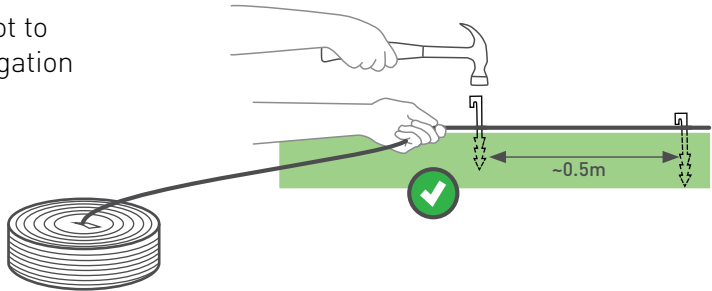

- Place the pegs every few tens of centimeters.
- Add pegs where necessary to keep the wire tight to the ground to avoid damaging it by the mower.

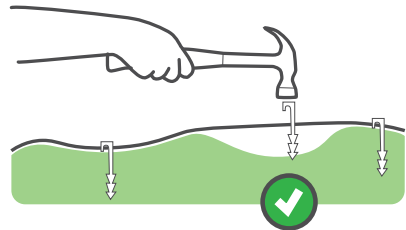

D. Protect obstacles

Hard obstacles

Obstacles that are vertical, rigid and higher than 15 cm (6 in), such as trees or telephone poles, do not need to be protected by the Perimeter Wire. The mower will bump into them and turn away.

Lower than 15 cm

Objects lower than 15 cm must be surrounded with the perimeter wire

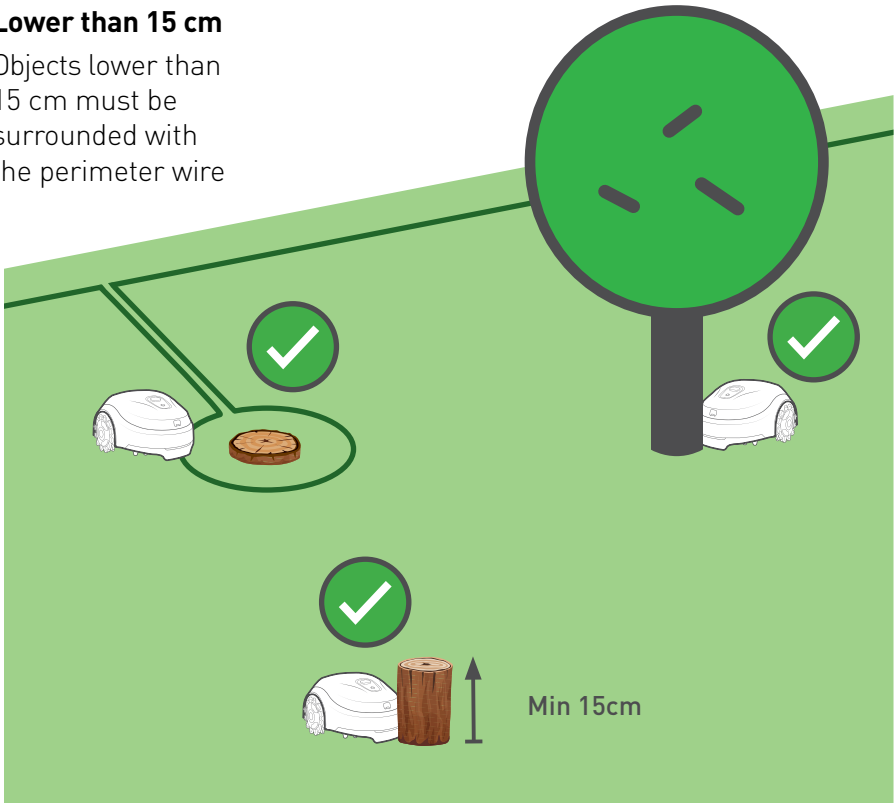

Soft obstacles

Objects such as flower beds, ponds, or small trees must be protected by setting Perimeter Islands.

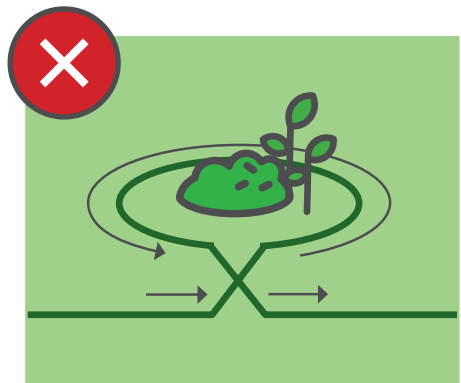
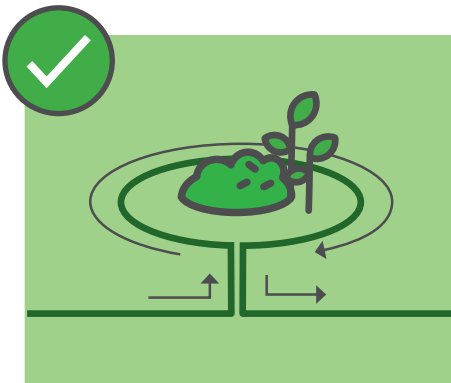
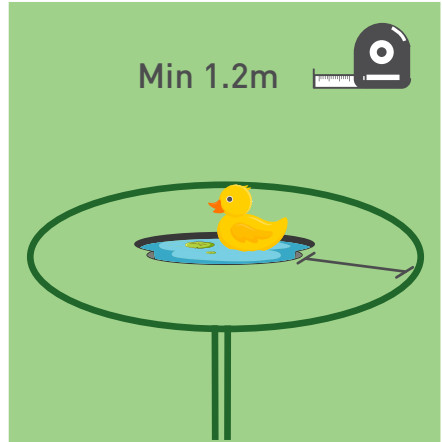
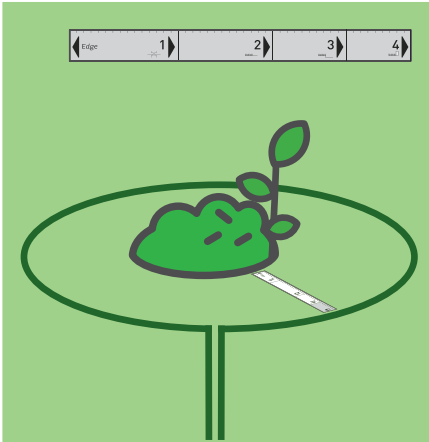

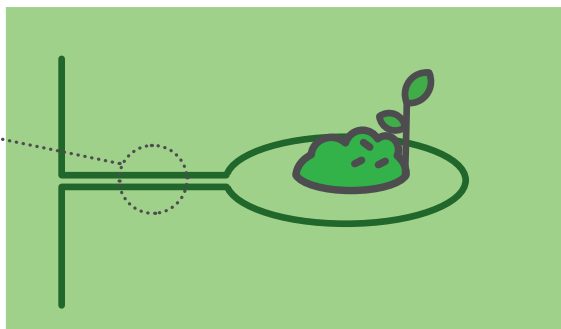
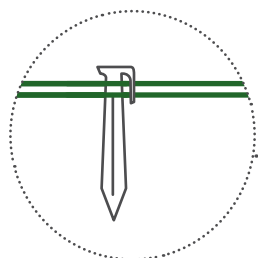
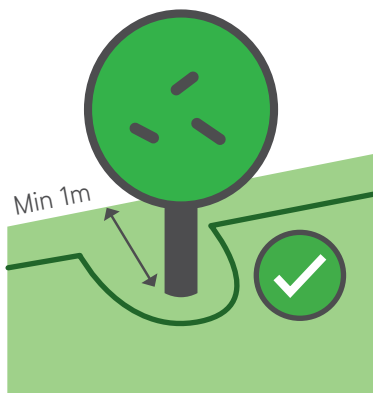
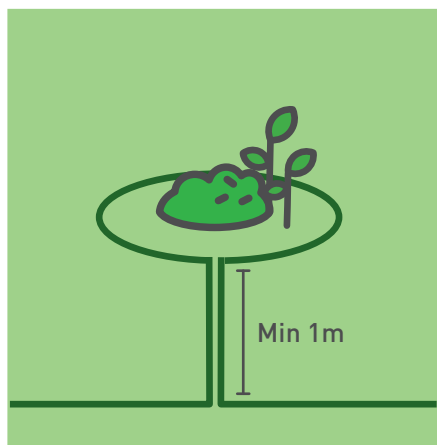

Tree roots, which stick out more than 2 cm above the ground, should be protected by a perimeter island.



Set the Perimeter Wire **CLOCKWISE** around the obstacle, otherwise the mower will drive into the Perimeter Island or won't be able to mow the area around it properly.

E. What if you have secondary areas?

If your lawn has additional areas as shown below, see Appendix B.

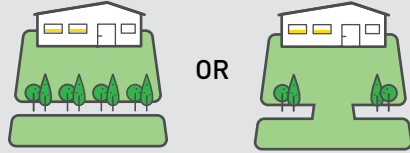

F. Complete wire setup

- Arrive back to the base location until the two wire ends meet each other
- Put the last peg very close to the first one

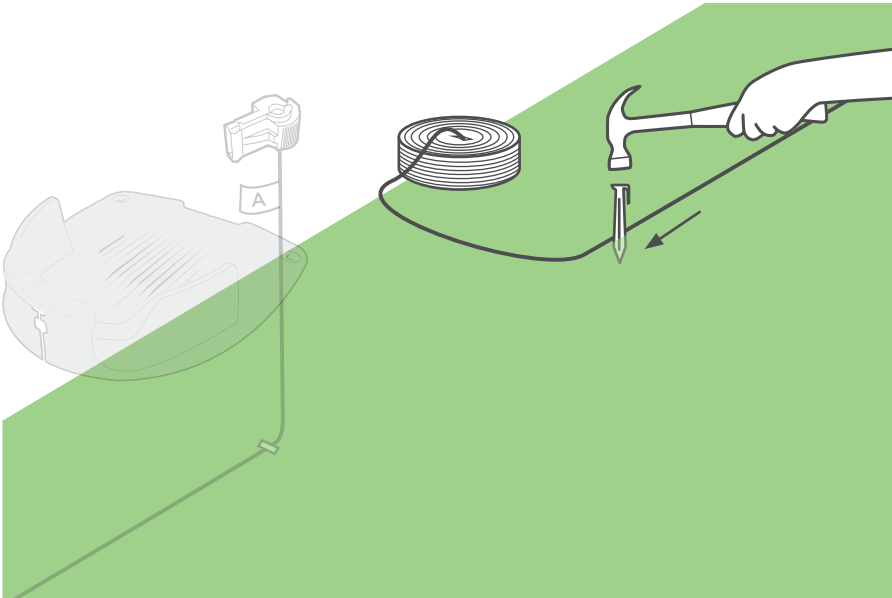

Make both wires end the same length. Use a cutter to cut off the remaining wire. Do not leave or create wire wraps

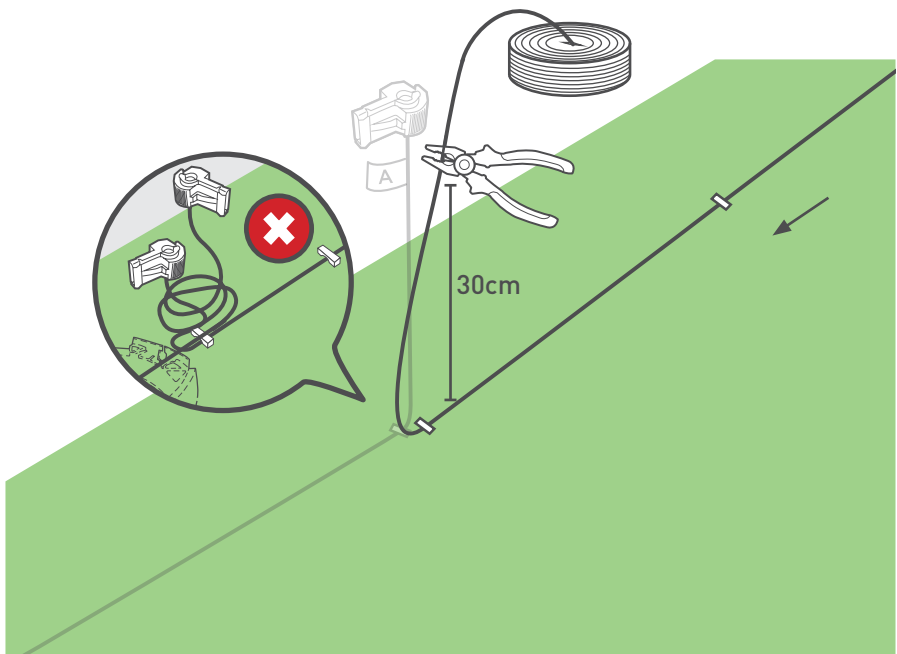

- Put one of the provided plot connectors on the second wire end
- Use pliers to press the connector and a cutter to cut off the remaining wire

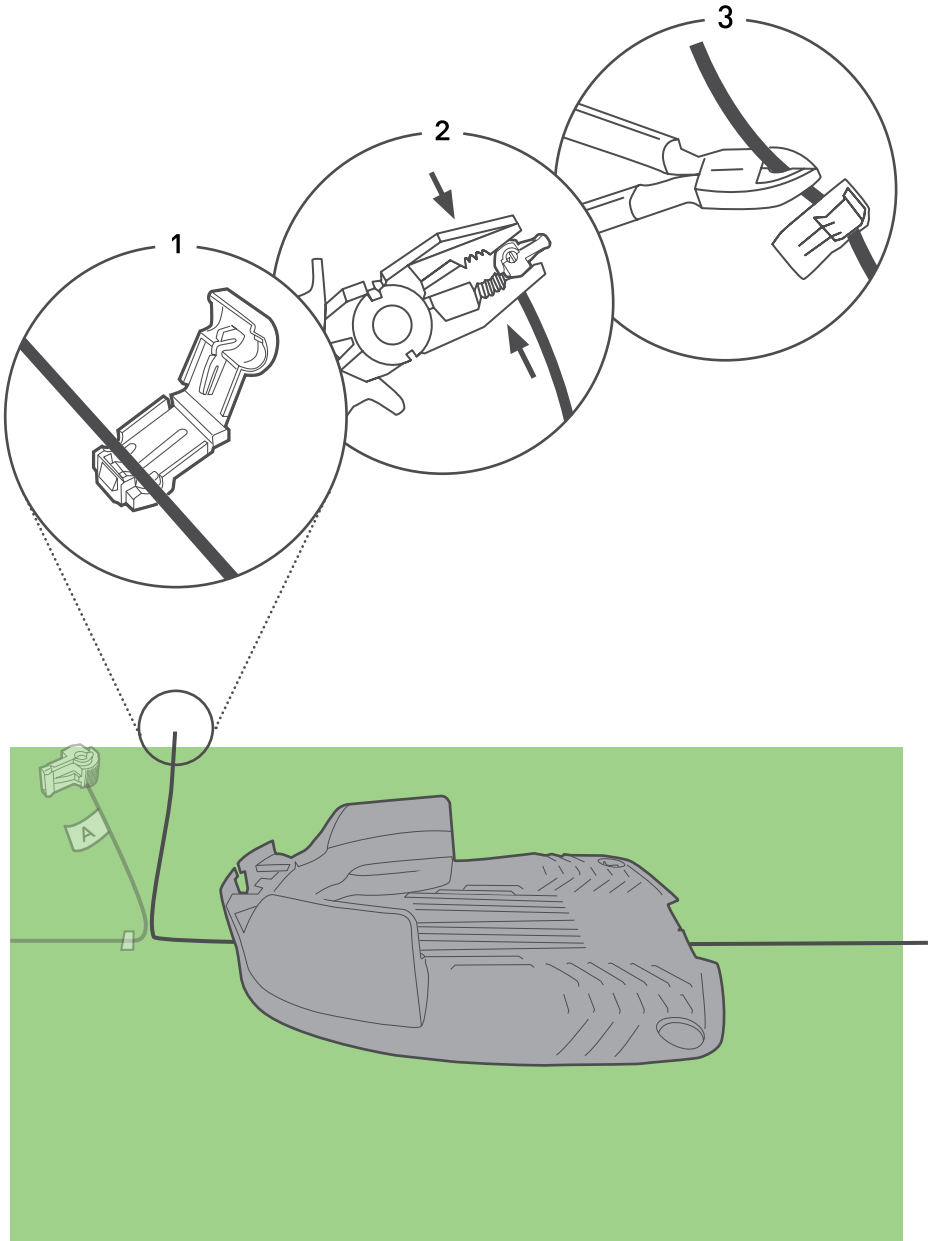

3 Set base

- Place the Base Station in its planned location
- Properly align the center of the Base Station with the Perimeter Wire

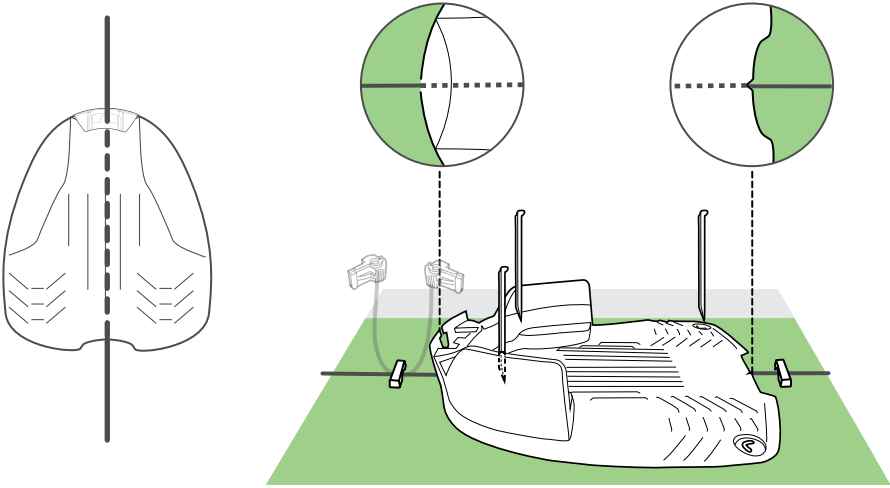

- Fix the base to the ground with the 4 supplied metal stakes

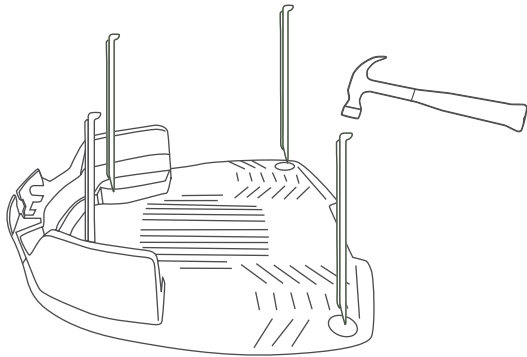

Be careful not to damage irrigation pipes when hammering down the stakes.

4 Power up

1. Thread the wires through the base station head adapter

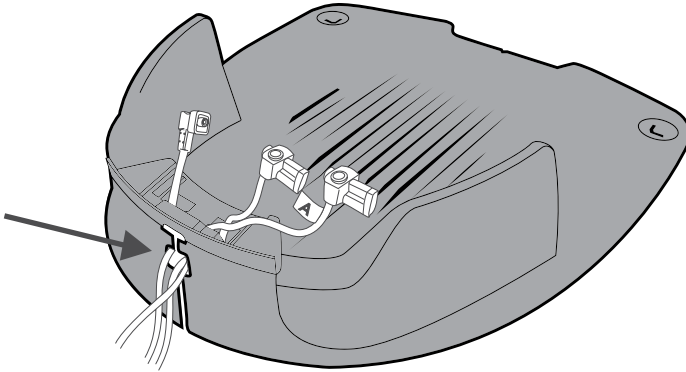

2. Connect the wire tail marked A to the A terminal and the other tail to the B terminal of the Base Station head.
3. Connect the power supply connector to the Base Station head as well.

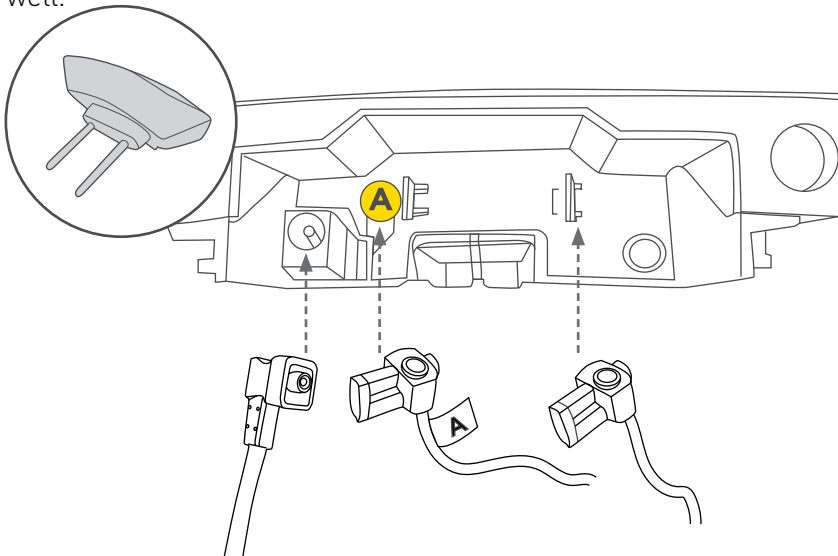

4. Place the head on the Base Station head adapter and align it with the markings as shown in the picture below.

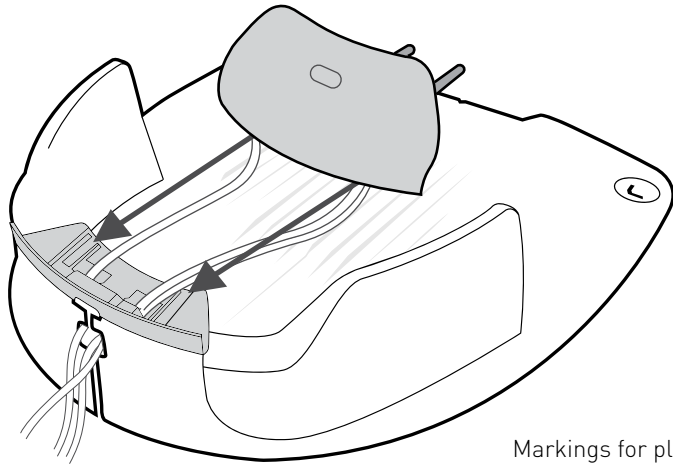

Markings for placing the Base Station Head

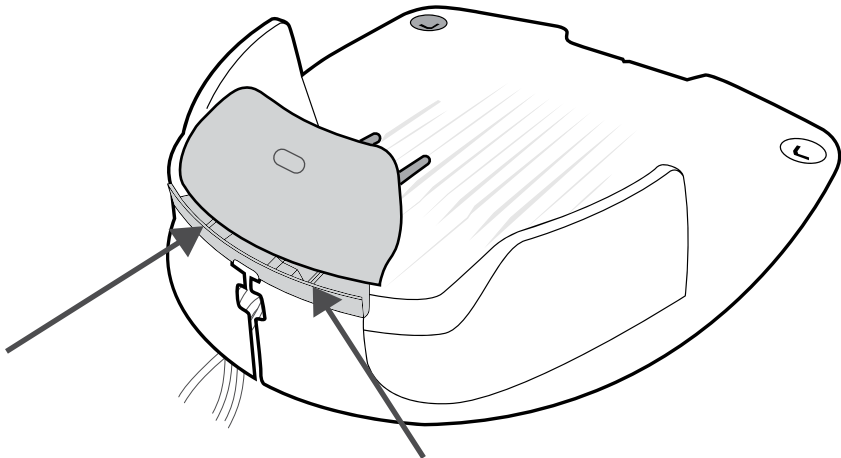

5. Slide the head all the way through.
Pay attention to the sliders and a dedicated slot for threading the wires.

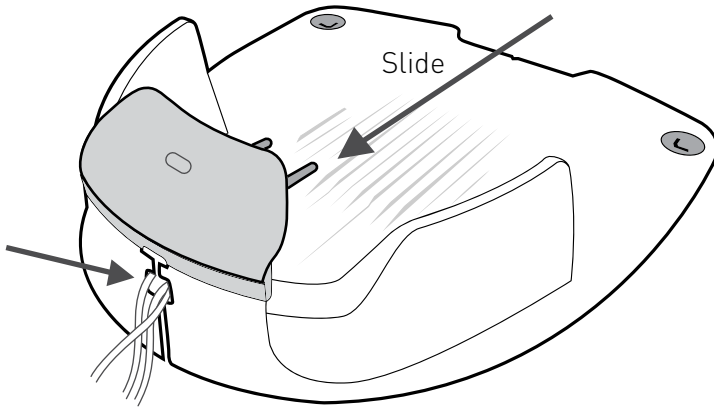

If for some reason you need to remove the base station head, you can do so by lifting the lever (A) with a flat screwdriver and pushing it towards the inside of the base.

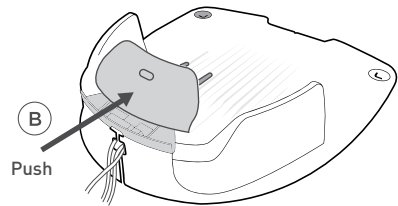
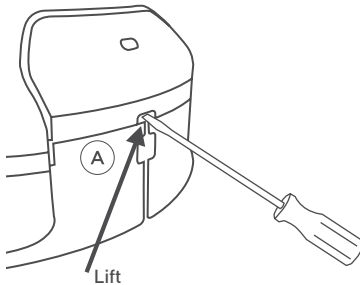

7. Plug in the power supply into a socket.

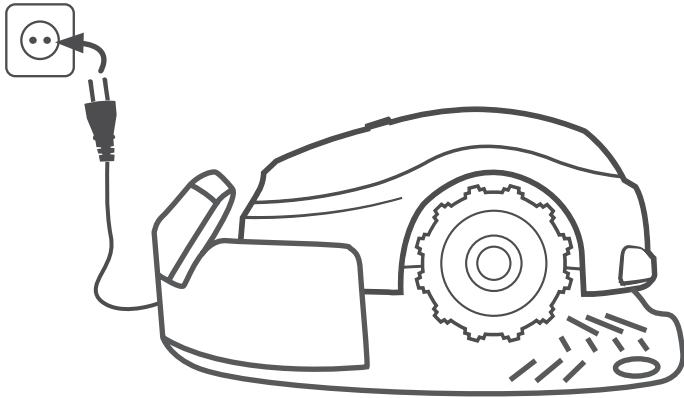

Take the power cord out of the mowing area (to prevent the mower from damaging it) and secure the cord firmly to the ground (so that it does not become a tripping hazard).

5 GO!

- Place your mower in the center of your lawn
- Press Mow for 2 seconds to switch it on
- Now press the STOP / 🏠 once to send the mower to the Base Station.

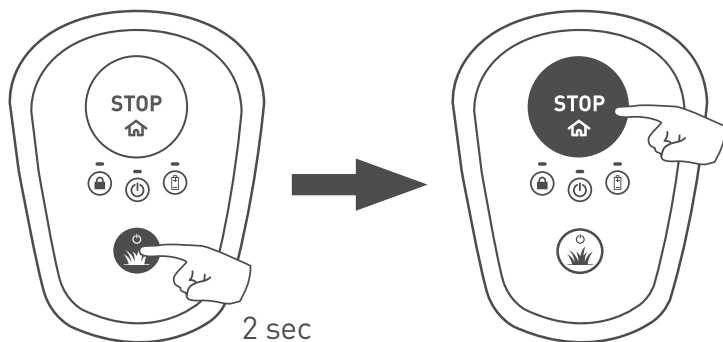

- The mower will start driving towards the edge of the lawn to locate the Perimeter Wire. Once on it, the mower will follow the wire to reach the Base Station and park there for charging.

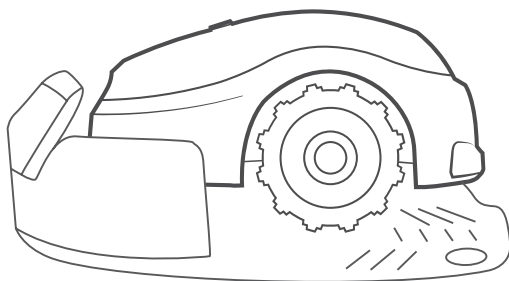

Operating your mower is super easy! For basic commands and troubleshooting, please refer to the “Quick Reference” part.

Your mower is ready!

Well Done!

***Now relax, and let your
mower do the work.***

Quick reference

- 1** ***Knowing your mower***
- 2** ***Single-button operation***
- 3** ***Additional options with the mobile app***
- 4** ***Taking care of your mower***
- 5** ***Troubleshooting***
- 6** ***FAQs***

1 **Knowing your mower**

In order to fully enjoy your mower, learn about its different parts and messages. Understanding how it works and interacts will lead to smooth and easy operation.

Front side

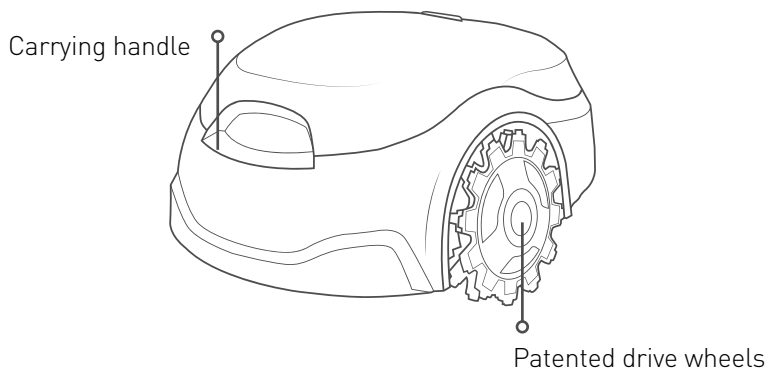

Rear side

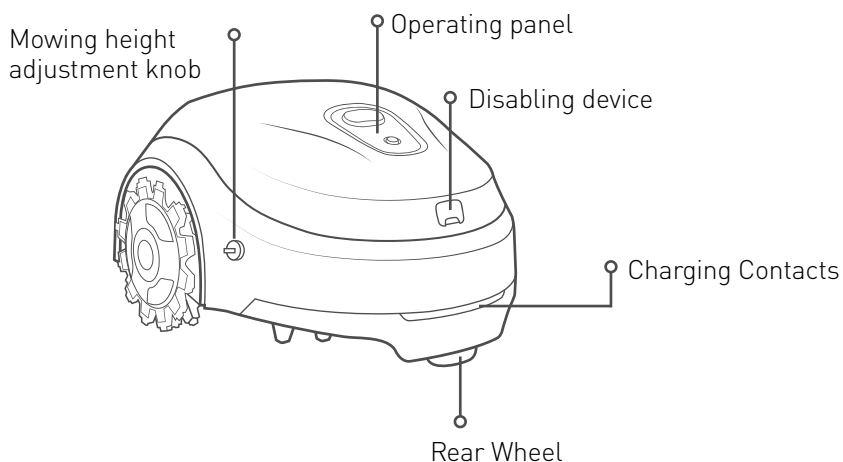

Bottom view

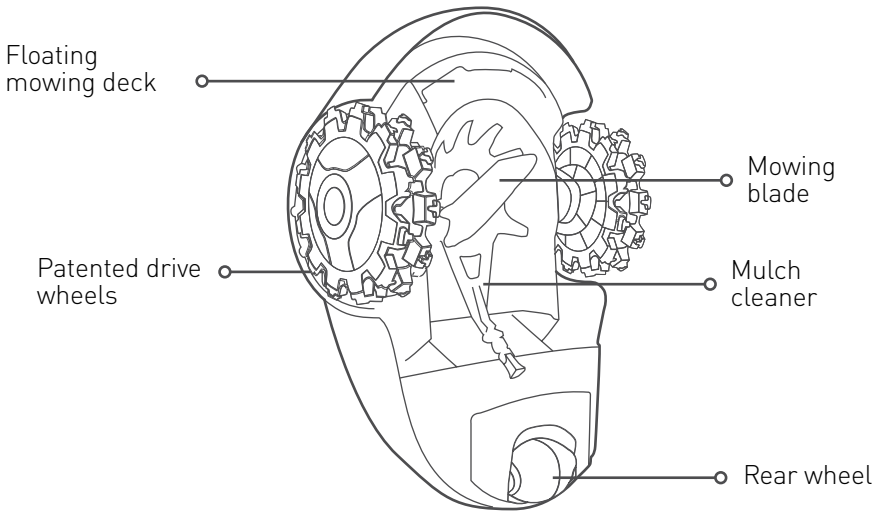

Operating panel

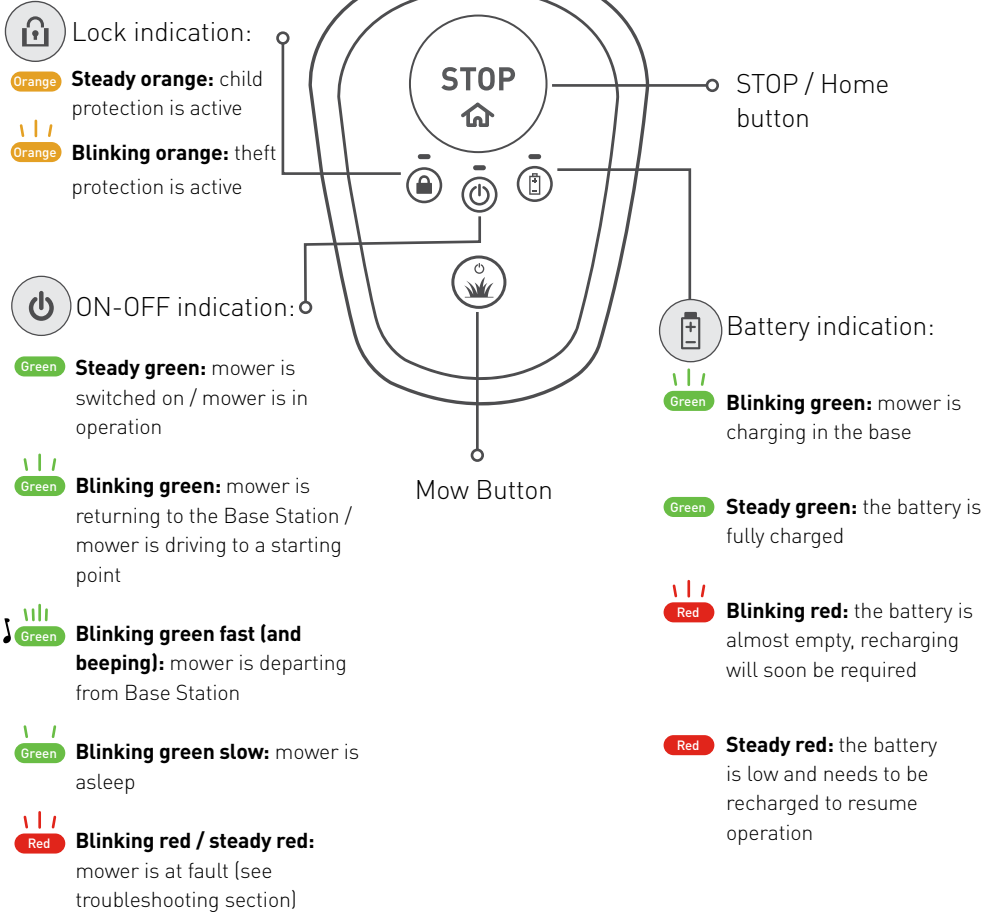

Base Station

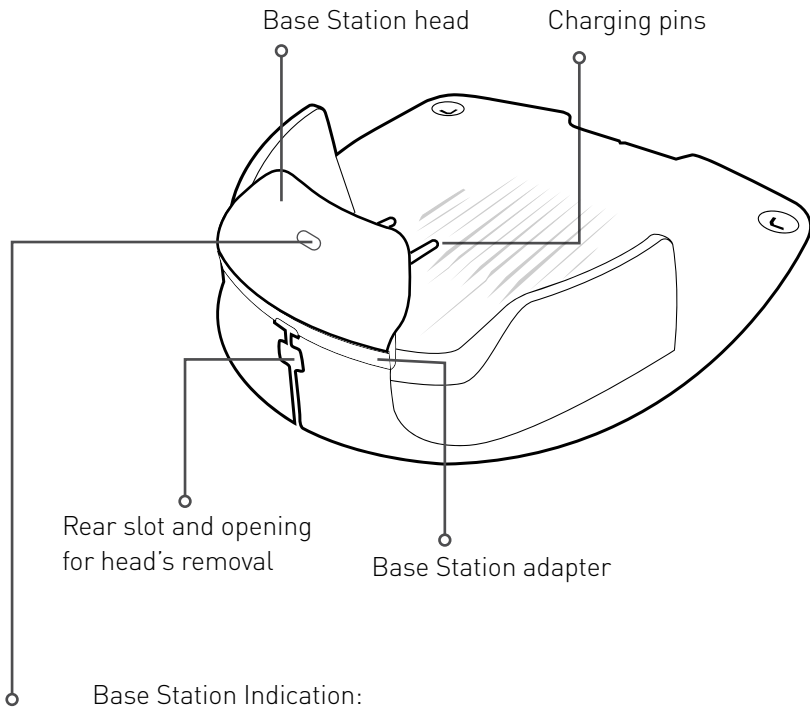

Base Station Indication:

Green

Steady green: perimeter wire signal is OK; the mower is inside the base



Green

Blinking green: perimeter wire signal is OK; the mower is outside the base



Red

Blinking red fast: perimeter wire is damaged or disconnected



Red

Blinking red slow: poor perimeter wire connection or the wire is too long



Red

Steady red: faulty power supply

2 Single-button operation

Before anything else



WARNING

Do not leave the mower to operate unattended if you know that there are pets, children or people in the vicinity. Never mow while people (especially children) or pets are nearby.

- Set the mowing height to the desired level. We recommend setting the mowing height to the maximum during the first mowing operation or at the beginning of a season, and then gradually reducing it to the desired level.

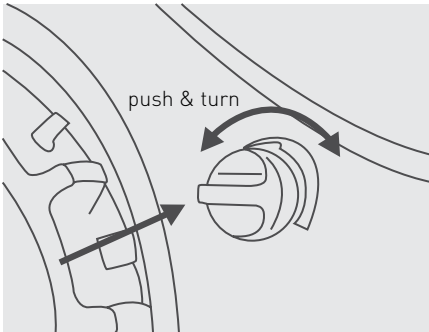

To set the mowing height, push and turn the mowing height adjustment knob to the desired direction:

- I means the lowest mowing height (15 mm / 0.6")
- IIII means the highest mowing height (60 mm / 2.4")



- Your mower is designed for frequent cutting at a desired height
- Before the first use, make sure your grass is cut not higher than 40 mm (1.6")



CAUTION

Clean the lawn from stones, fallen branches or other foreign objects before using the mower. The limited warranty of your mower does not cover damages caused by objects left in the lawn.

Powering up

To power up your mower, press and hold the Mow button for 2 seconds until the ON/OFF indication is lit.

When you need to switch it off, simply press and hold Mow button for 2 seconds, until the ON/OFF indication goes off.

Note: If the theft protection is enabled, you will need to unlock your mower via the mobile app before you can switch it off.

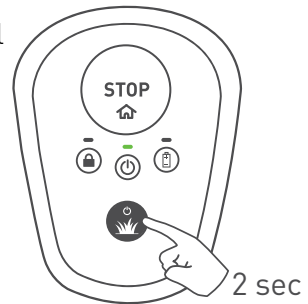

Enabling child protection

Child protection prevents accidental use of the mower by little children. When child protection is enabled, the mower will require a special combination to start a mowing operation or to go back to its base.

To enable child protection, press and hold the Mow + STOP buttons together for 6 seconds.

If you wish to disable child protection, press and hold the Mow + STOP buttons together for 6 seconds again.

Alternatively, child protection can be enabled or disabled conveniently via the mobile app

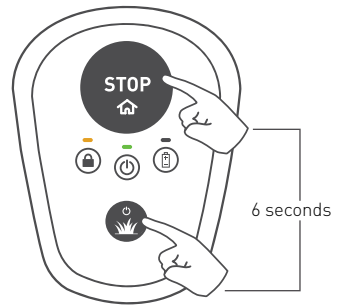

Starting a mowing operation

Starting a mowing operation is super easy!

If you wish to start a **manual mowing operation**, all you need to do is to press the Mow button once.

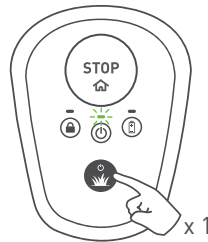

If the regular mowing duration (depends on a particular model of your mower) is too long for your lawn, you can initiate half-time mowing operation by pressing the Mow button twice.

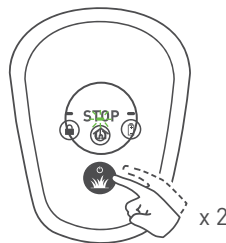

When child protection is enabled, a special combination of keys is required to start a mowing operation. Hold down the STOP button and press the Mow button once to unlock the child protection for 2 minutes. The Lock indication will be temporarily switched off. Now you can start a mowing operation as described above. As soon as the mowing operation is started, the child protection will automatically relock itself.

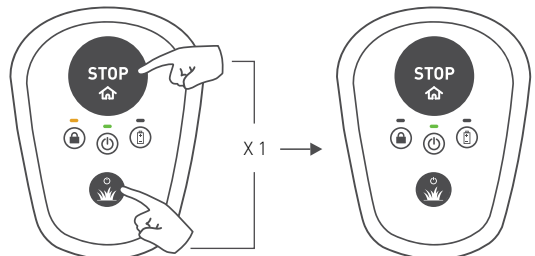

Stopping an operation

To stop any current operation, press the STOP / ⏹ button.

Sending the mower to its base

To send the mower to its base, simply press the STOP / ⏹ button when the mower is inside the lawn.

If child protection is enabled, see the “Starting mowing operation” section above to temporarily unlock it. Then press STOP / ⏹ button to send the mower to its base. The child protection will relock automatically.

Automatic charging

Once a mowing operation is finished, your mower automatically returns to its base station for charging to be ready for the next operation.

How much mowing does your lawn need?

The amount of mowing depends on a season and on the size of your lawn. We recommend the following amounts of weekly mowing times per lawn size in peak season.

When registering your mower via the app, the default mowing plan will be presented according to the defined lawn size.

Lawn size *	Active days	No of daily operations
0 - 100 m ²	Mon, Wed, Fri	1
100 - 200 m ²	Mon - Sat	1
200 - 300 m ²	Mon - Sat	2
300 - 400 m ²	Mon - Sat	3
400 - 500 m ²	Mon - Sat	3
500 - 600 m ²	Mon - Sat	4
600 - 700 m ²	Mon - Sat	4

[*] Check the recommended lawn size in your mower's specifications



For the best look of your lawn, we recommend spreading the mowing times evenly among as many days in a week as possible.

3

Additional options with the mobile app

Your mower is a smart connected product. It comes with a built-in Bluetooth LE (Low Energy) device that enables you to control your mower from your smartphone.

A free complementary mobile app will allow you to experience your mower in a whole different way!

You can download the Robomow app from Google Play Store (Android) or from Apple AppStore (iOS). After downloading, you can register your mower and enjoy much more.

Along with a totally exciting experience, it brings additional options and capabilities to your small and clever mower:

- **Setting automatic mowing schedule**

- Activating theft protection
- Defining additional starting points
- manual driving your mower
- mower diagnostics
- Avoiding interference by changing signal type
- Enabling "Energy Saver" mode to minimize power consumption to comply with CEC/DoE regulation.

4

Taking care of your mower

Periodic maintenance



WARNING

Severe injury and damage hazard!

Always switch the mower off before lifting it. The blade is very sharp. It can cause severe cuts or lacerations. Always wear heavy work gloves when working with or around the blade. NEVER use a damaged or broken blade. NEVER sharpen the blade.

Once a month:

- Inspect the underside of the mower. Clean if necessary. Carefully scrape the collected grass debris (using a small stick or similar object) from under the mowing deck.
- Check the Perimeter Wire and add pegs where it is loose and not tight to the ground. In case of seasonal changes in the lawn, make sure to adjust the wire accordingly.
- Inspect the Base Station, clean it from mud and debris to allow proper docking.



IMPORTANT!

NEVER use high pressure water to clean the mower. Liquids can damage components. Use only an air blower or wet cloth to wipe the surface clean.



To allow better maintenance and to keep your mower in good condition, it is recommended to take it to a certified dealer for service prior to winter storage.

*see further in this manual

Operating the Disabling Device

- The Disabling Device prevents the operation of your mower when it is removed. The mower will keep charging while in base.

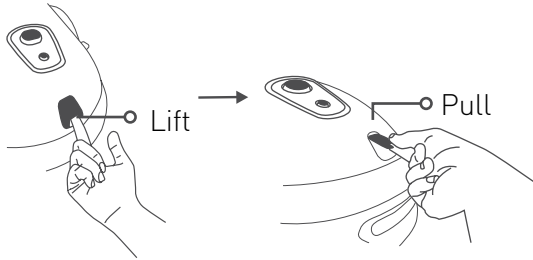

- If the Disabling Device is pulled out, the current operation will be immediately halted, the Lock indication will blink three times and the ON/OFF LED will switch off.
- If any button on mower's operating panel is pressed, the Lock indication will blink three times to indicate that the Disabling Device is missing.
- If theft protection is enabled, it will remain active even though the Disabling Device is removed.

Replacing the blade

1. Remove the Disabling Device.

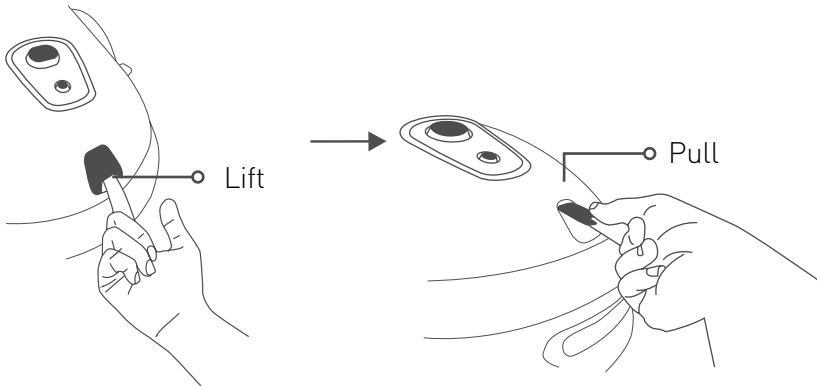

2. Power the mower off by pressing Mow button for 2 seconds.



3. Put on heavy-duty gloves, and place RoboTool over the blade so that it covers the whole blade.

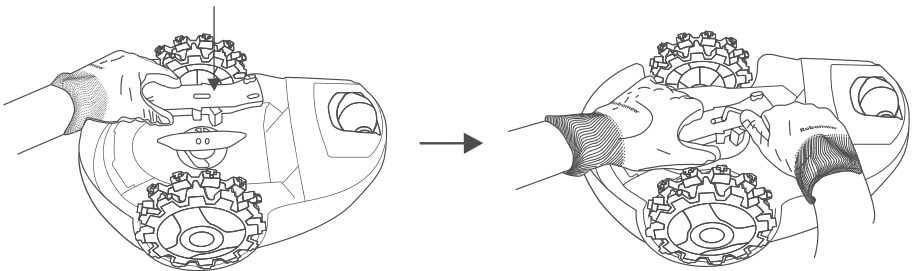

4. Use the provided Allen tool (comes with a replacing blade) to unscrew the screws while holding the blade with the RoboTool.

5. Replace the blade with a new one (Part No.MRK9100A/MRK9100W).

6. Make sure to close both screws tightly.

Winter storage

The mower

- Fully charge the mower in its base
- Switch the mower off by pressing the Mow button for 2 seconds
- Store the mower in dry indoor conditions at ambient temperatures above 0°C.

Base Station

- No winter storage is required for a Base Station. It can be left on the lawn during the winter period.
- It is required to disconnect the Power Supply from the mains during the winter storage period.

Winter service

- To allow better maintenance and to keep your mower in good condition, it is recommended to bring it to a certified dealer for service prior to winter storage.
- Winter service includes operations like cleaning the mower's parts and mowing deck, checking for worn parts (such as blade, drive wheels and other moving parts) and replacing them if required, testing the mower's functions and safety components, checking the battery, and uploading a latest software version, possibly including newly added features.



Battery replacement

1. Make sure the mower is not in the Base Station.
2. Power the mower off by pressing Mow button for 2 seconds.
3. Remove the Disabling Device.
4. Use only a battery that is specified by the manufacturer as a suitable replacement and ensure you are using the right type (Li-Ion) for your mower.
5. Warning! Do not use a non-rechargeable battery.
6. For the orientation of the battery with regard to polarity and the method of replacement, refer to the instructions supplied with the replacing battery or to our online Help Center.
7. For the instructions on how to deal with a leaking battery, refer to the “Batteries” section of the provided safety instructions.
8. Environmental protection:
 - a. Remove the battery from the appliance before scrapping it.
 - b. The battery is to be disposed of safely.
 - c. For additional disposal instructions see the “Product end of use” section of the provided safety instructions.

5 Troubleshooting

Simple troubleshooting steps

In case of a fault, the On/Off indication on mower's panel will light up in red. Press any button to check for an optional sound indication for the fault. The table below will guide you to the corresponding action to take.

No. of beeps	ON-OFF indication	Meaning	Corrective action
•	Blinking red	Mower crossed outside / mower is stuck in place / lift event detected/ wrong wire connection	<ul style="list-style-type: none"> • Check that the Perimeter Wire is not too close to the edge or not on a sloped area. • Move the mower inside the lawn or away from this particular location and renew the operation. • Check the ground ditches. Fill with dirt and level off. • Swap wire connections at the base station head
••	Blinking red	Check the blade / mow motor overheat	<ul style="list-style-type: none"> • Remove the Disabling Device and inspect the blade for foreign material or debris preventing rotation. • Increase cutting height.
•••	Blinking red	No wire signal / waiting for signal / wire is cut	<ul style="list-style-type: none"> • Confirm power supply is plugged into the power outlet. • Check power supply and perimeter wire connection to the Base Station. • Check the indication on the Base Station. If the wire is cut, repair is with the provided wire connectors.

No. of beeps	ON-OFF indication	Meaning	Corrective action
••••	Blinking red	Check drive wheels / drive motor overheat	<ul style="list-style-type: none"> Remove the Disabling Device and Check the drive wheels and remove grass or other objects.
None	Blinking red (two LEDs)	No power supply / charging problem	<ul style="list-style-type: none"> Confirm power supply is plugged into the power outlet. Confirm a good connection of the power supply to the Base Station. Clean the charging pins.
None	Steady red	Other faults	<ul style="list-style-type: none"> Check in the mobile app* or call the service.

(*) All faults and corresponding corrective actions are communicated and described in the app as well.

Special indications

Indication	Meaning
Periodic beeps + ON/OFF LED is red	The mower has been lifted or tilted up.
Error sound + Battery LED blinks red two times	Mowing attempt while the battery is low. Need to recharge battery first.
Error sound + Lock LED blinks two times	Mowing attempt while child protection is enabled. Press the Mow and STOP buttons together to temporary release the child protection. Now press Mow once or twice to start mowing.
Error sound + Lock LED blinks three times	Mowing attempt while theft protection is enabled. Unlock the mower with a registered mobile device first.
ON/OFF LED & Battery LED blink together in red, when the Mow button is pressed	Battery voltage is too low to switch the mower on. Need to keep charging.
Lock LED blinks three times while ON/OFF LED is off	The Disabling Device is removed. Insert the Disabling Device to operate the mower.

Rebooting your mower

If for some reason your mower needs to be rebooted, simply switch it off by pressing the 'Power' button for 2sec.

Resetting the mower to factory defaults

When it is required to bring the mower to its factory defaults, you may do so by pressing the Mow button for more than 10 seconds (until you hear a long beep and all LEDs start blinking) while the mower is switched off.

6

Frequently Asked Questions



Mower does not dock properly and sometimes misses Base Station's contacts

The entrance to the Base Station is not flat. Fill some ground to flatten the lawn around the Base Station to allow smooth entrance. Make sure the Perimeter Wire is laid according to the installation instructions on the supplied installation guide. Make sure that the Base Station is placed on a relatively level ground.



Poor mowing quality

The blade may be dull. Remove the Disabling Device. Put on heavy-duty gloves and inspect the blade. Replace if needed. Avoid mowing wet grass. For the best cut, operate your mower when the grass is dry. It is recommended not to mow in the early morning hours.



Patchy and uneven mowing

Current mowing times are not enough. Increase the time your mower runs on the lawn. Add additional operations per day (depends on model) or add starting points for a more uniform coverage.



Mower does not depart from base for a long time

Use the mobile app, click the bottom right mower icon to open the info screen to understand the reason for the non-departure.



Mower bumps in a rigid lawn's border too frequently

Move the Perimeter Wire to be at a distance of 47 cm /18.5" from any rigid border (like a fence) at the lawn's edge.



The mower is very noisy

The blade may be damaged or unbalanced. Check if the lawn is free from branches, stones or other objects that can damage the blade. Replace the blade if needed.

Appendix A

Additional installation options

1. **Internal** corner installation.

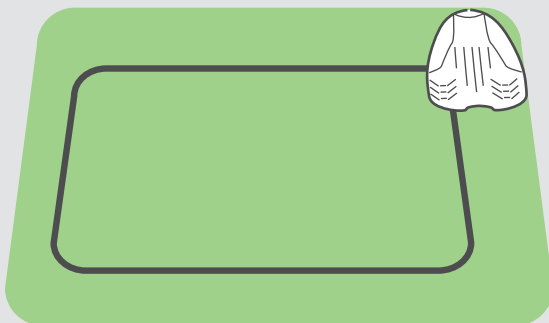

Refer to our online Help Center from the mobile app for additional information.

2. **External** corner installation.

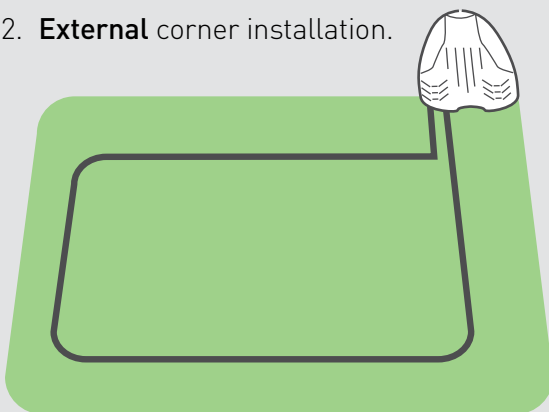

Refer to our online Help Center from the mobile app for additional information.

Requires configuring starting points via the app

Appendix B Secondary areas

Connected secondary areas

If your lawn has additional areas connected with a passage and the mower is able to drive through it, then you should bear in mind the following rules:

- The minimal distance between the wires in such passage should be 15 cm / 6"
- The minimal width of such passage should be 80 cm / 2.5ft

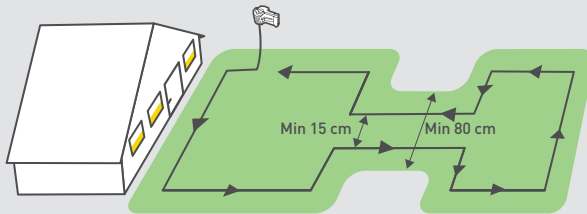

Separated secondary areas

If your lawn has areas, that are completely separated (by a fence, sidewalk, pathway, etc.), then you can extend the perimeter wire to cover such secondary areas as shown in the picture below.

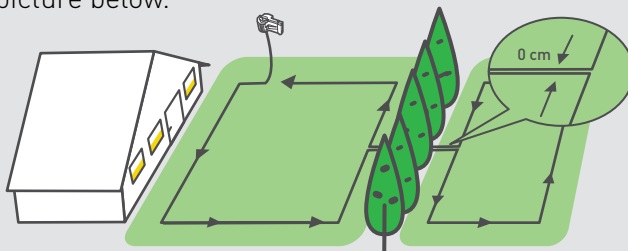

Appendix C

Operating basics

What to do

How to do it

Switch ON/OFF

Hold  for 2 seconds

Start regular mowing operation (up to 2 hours)

Press  once

Start short mowing operation (60 min)

Press  twice

Send the mower to the Base Station

Press  when idle

Common indications:

Blinking green: The mower is charging in the Base Station.

Blinking red: There is a fault; go to the “Troubleshooting” section of this guide or connect with the mobile app for more information.

Blinking red fast: The perimeter wire is cut. Check the Perimeter Wire’s connection to the Base Station. Refer to our online Help Center for assistance on finding a wire break.

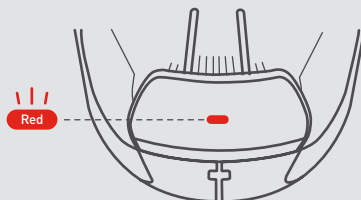
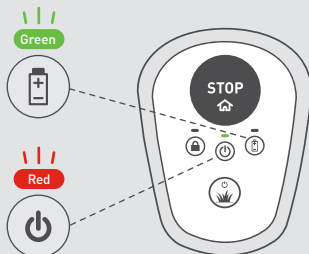

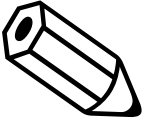



MTD Products Aktiengesellschaft Industriestraße 23 | 66129 Saarbrücken | Germany

robomow.com 